

**GaAs-IR-Lumineszenzdiode**  
**GaAs Infrared Emitter**  
**Lead (Pb) Free Product - RoHS Compliant**

**SFH 4511**



**Wesentliche Merkmale**

- GaAs-LED mit sehr hohem Wirkungsgrad
- 5mm Kunststoffgehäuse
- Peakwellenlänge 950 nm
- Sehr enger Abstrahlwinkel ( $\pm 4^\circ$ )
- Hohe Strahlstärke
- Hohe Zuverlässigkeit

**Features**

- Very highly efficient GaAs-LED
- 5mm plastic package
- Peak Wavelength 950 nm
- Very narrow radiation Angle ( $\pm 4$  Deg.)
- High radiant intensity
- High reliability

**Anwendungen**

- IR-Fernsteuerung von Fernseh- und Rundfunkgeräten, Videorecordern, Lichtdimmern
- Gerätefernsteuerungen für Gleich- und Wechsellichtbetrieb
- Sensorik
- Diskrete Lichtschranken

**Applications**

- IR remote control of hi-fi and TV-sets, video tape recorders, dimmers
- Remote control for steady and varying intensity
- Sensor technology
- Discrete interrupters

Typ Type	Bestellnummer Ordering Code	Strahlstärkegruppierung <sup>1)</sup> ( $I_F = 100$ mA, $t_p = 20$ ms) Radiant Intensity Grouping <sup>1)</sup> $I_e$ (mW/sr)
SFH 4511	Q62702Q5557	> 63 (typ. 150)

<sup>1)</sup> gemessen bei einem Raumwinkel  $\Omega = 0.001$  sr / measured at a solid angle of  $\Omega = 0.001$  sr

**Grenzwerte** ( $T_A = 25\text{ °C}$ )**Maximum Ratings**

Bezeichnung Parameter	Symbol Symbol	Wert Value	Einheit Unit
Betriebs- und Lagertemperatur Operating and storage temperature range	$T_{op}; T_{stg}$	- 40 ... + 100	°C
Sperrspannung Reverse voltage	$V_R$	5	V
Durchlassstrom Forward current	$I_F$	100	mA
Stoßstrom, $t_p = 10\text{ }\mu\text{s}$ , $D = 0$ Surge current	$I_{FSM}$	3	A
Verlustleistung Power dissipation	$P_{tot}$	165	mW
Wärmewiderstand Thermal resistance	$R_{thJA}$	450	K/W

**Kennwerte** ( $T_A = 25\text{ °C}$ )**Characteristics**

Bezeichnung Parameter	Symbol Symbol	Wert Value	Einheit Unit
Wellenlänge der Strahlung Wavelength at peak emission $I_F = 100\text{ mA}$ , $t_p = 20\text{ ms}$	$\lambda_{peak}$	950	nm
Spektrale Bandbreite bei 50% von $I_{max}$ Spectral bandwidth at 50% of $I_{max}$ $I_F = 100\text{ mA}$	$\Delta\lambda$	55	nm
Abstrahlwinkel Half angle	$\varphi$	$\pm 4$	Grad deg.
Aktive Chipfläche Active chip area	$A$	0.09	mm <sup>2</sup>
Abmessungen der aktiven Chipfläche Dimensions of the active chip area	$L \times B$ $L \times W$	$0.3 \times 0.3$	mm <sup>2</sup>
Schaltzeiten, $I_e$ von 10% auf 90% und von 90% auf 10%, bei $I_F = 100\text{ mA}$ , $R_L = 50\text{ }\Omega$ Switching times, $I_e$ from 10% to 90% and from 90% to 10%, $I_F = 100\text{ mA}$ , $R_L = 50\text{ }\Omega$	$t_r, t_f$	0.5	$\mu\text{s}$

Kennwerte ( $T_A = 25\text{ °C}$ )

Characteristics (cont'd)

Bezeichnung Parameter	Symbol Symbol	Wert Value	Einheit Unit
Kapazität, Capacitance $V_R = 0\text{ V}, f = 1\text{ MHz}$	$C_o$	25	pF
Durchlassspannung Forward voltage $I_F = 100\text{ mA}, t_p = 20\text{ ms}$ $I_F = 1\text{ A}, t_p = 100\text{ }\mu\text{s}$	$V_F$ $V_F$	1.3 ( $\leq 1.5$ ) 2.3 ( $\leq 2.8$ )	V V
Sperrstrom Reverse current $V_R = 5\text{ V}$	$I_R$	0.01 ( $\leq 1$ )	$\mu\text{A}$
Gesamtstrahlungsfluss Total radiant flux $I_F = 100\text{ mA}, t_p = 20\text{ ms}$	$\Phi_e$	22	mW
Strahlstärke Radiant intensity $I_F = 1\text{ A}, t_p = 100\text{ }\mu\text{s}$	$I_{e\text{ typ.}}$	1200	mW/sr
Temperaturkoeffizient von $I_e$ bzw. $\Phi_e$ , $I_F = 100\text{ mA}$ Temperature coefficient of $I_e$ or $\Phi_e$ , $I_F = 100\text{ mA}$	$TC_I$	- 0.5	%/K
Temperaturkoeffizient von $V_F$ , $I_F = 100\text{ mA}$ Temperature coefficient of $V_F$ , $I_F = 100\text{ mA}$	$TC_V$	- 2	mV/K
Temperaturkoeffizient von $\lambda$ , $I_F = 100\text{ mA}$ Temperature coefficient of $\lambda$ , $I_F = 100\text{ mA}$	$TC_\lambda$	+ 0.3	nm/K

**Strahlstärke  $I_e$  in Achsrichtung**gemessen bei einem Raumwinkel  $\Omega = 0.001$  sr**Grouping of Radiant Intensity  $I_e$  in Axial Direction**at a solid angle of  $\Omega = 0.001$  sr

Bezeichnung Parameter	Symbol	Wert Value	Einheit Unit
Strahlstärke Radiant intensity $I_F = 100$ mA, $t_p = 20$ ms	$I_{e \text{ min.}}$ $I_{e \text{ typ.}}$	63 150	mW/sr mW/sr
Strahlstärke Radiant intensity $I_F = 1$ A, $t_p = 100$ $\mu$ s	$I_{e \text{ typ.}}$	1200	mW/sr

**Relative Spectral Emission**

$I_{rel} = f(\lambda)$

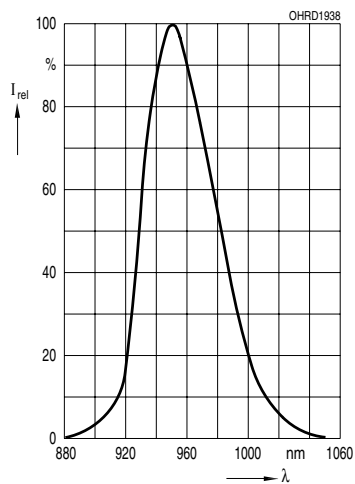

**Radiant Intensity**  $\frac{I_e}{I_e 100 \text{ mA}} = f(I_F)$

Single pulse,  $t_p = 20 \mu\text{s}$

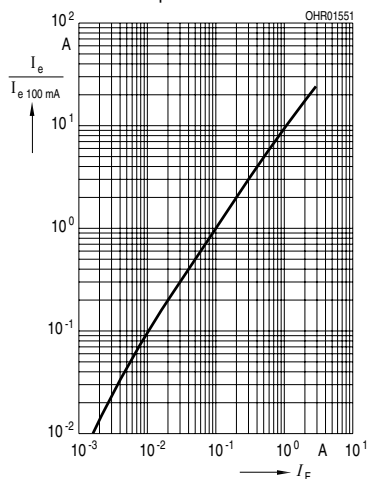

**Max. Permissible Forward Current**

$I_F = f(T_A)$

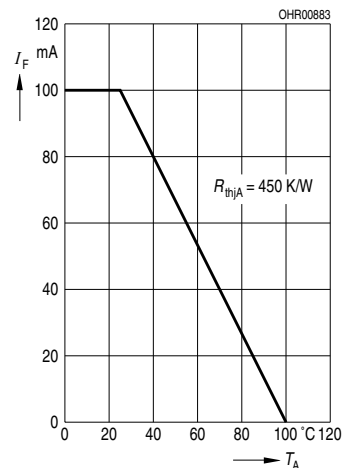

**Forward Current**

$I_F = f(V_F)$ , single pulse,  $t_p = 20 \mu\text{s}$

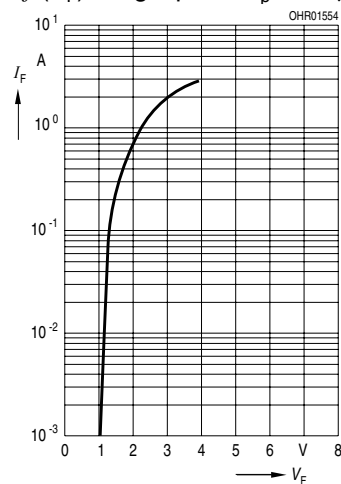

**Radiation Characteristics,**

$I_{rel} = f(\varphi)$

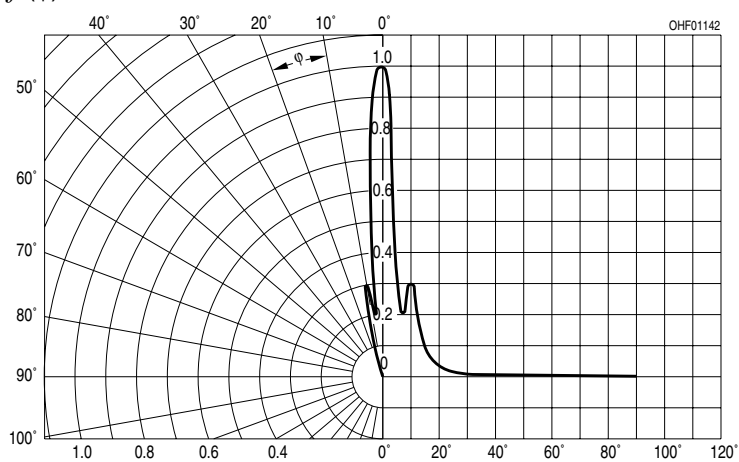

**Permissible Pulse Handling Capability**

$I_F = f(\tau)$ ,  $T_A = 25 \text{ }^\circ\text{C}$

duty cycle  $D = \text{parameter}$

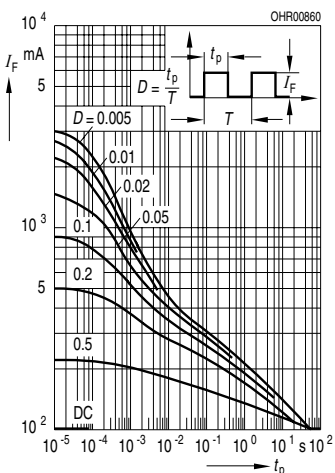

## Maßzeichnung Package Outlines

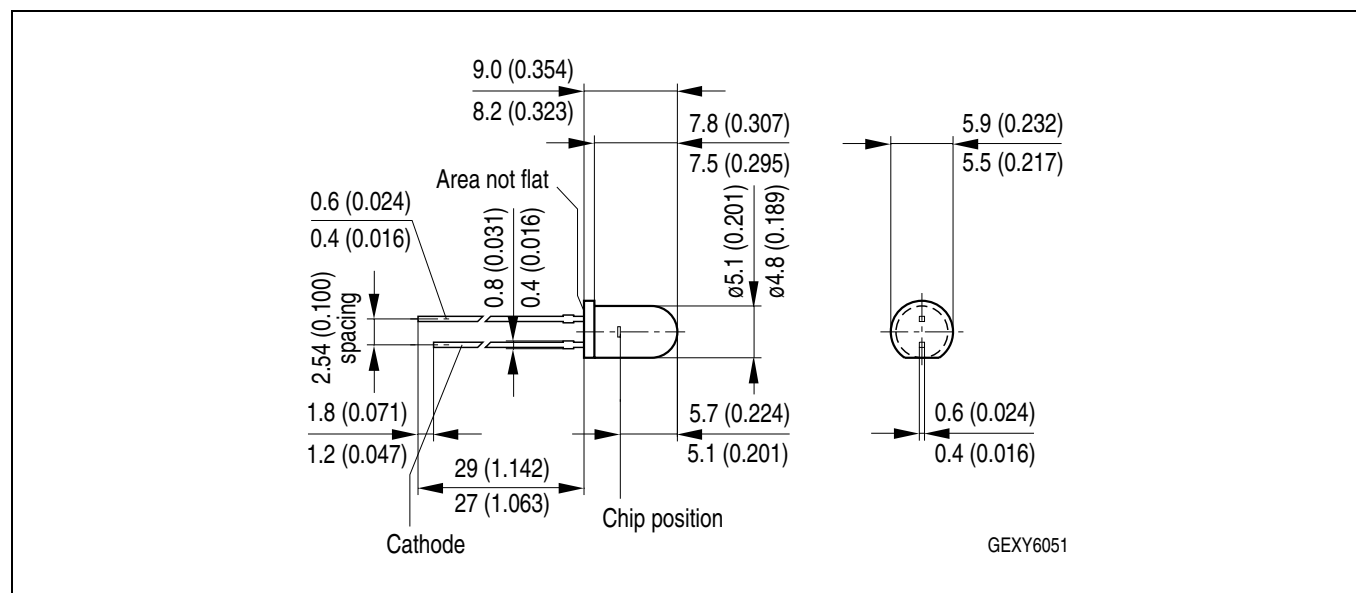

Maße in mm (inch) / Dimensions in mm (inch).

<b>Package</b>	5 mm radial (T 1 <sup>3/4</sup> )
<b>Colour</b>	black

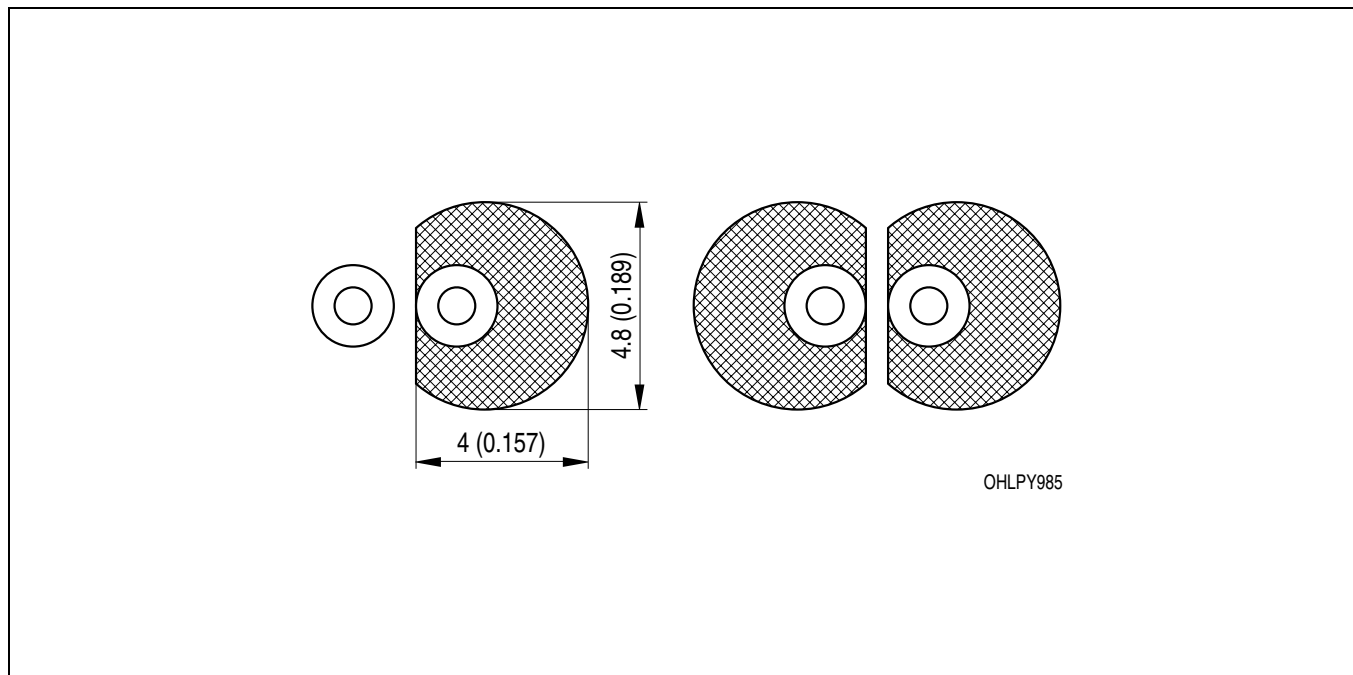
**Empfohlenes Lötpad-Design**  
**Recommended Solder Pad****Wellenlöten (TTW)**  
**TTW Soldering**

Maße in mm (inch) / Dimensions in mm (inch).

**Lötbedingungen**  
**Soldering Conditions**  
**Wellenlöten (TTW)**  
**TTW Soldering**

(nach CECC 00802)  
(acc. to CECC 00802)

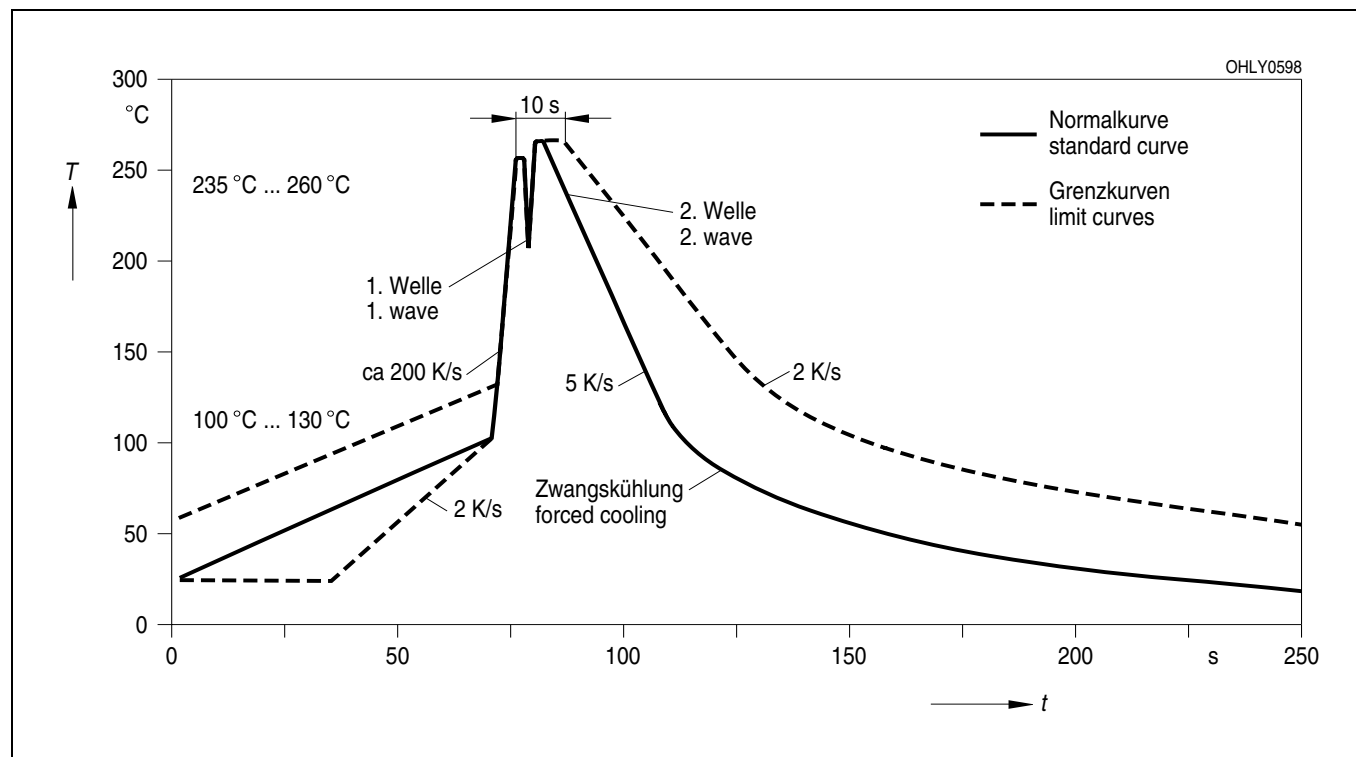

Published by  
**OSRAM Opto Semiconductors GmbH**  
Wernerwerkstrasse 2, D-93049 Regensburg  
[www.osram-os.com](http://www.osram-os.com)

© All Rights Reserved.

The information describes the type of component and shall not be considered as assured characteristics. Terms of delivery and rights to change design reserved. Due to technical requirements components may contain dangerous substances. For information on the types in question please contact our Sales Organization.

**Packing**

Please use the recycling operators known to you. We can also help you – get in touch with your nearest sales office. By agreement we will take packing material back, if it is sorted. You must bear the costs of transport. For packing material that is returned to us unsorted or which we are not obliged to accept, we shall have to invoice you for any costs incurred.

**Components used in life-support devices or systems must be expressly authorized for such purpose!** Critical components<sup>1</sup>, may only be used in life-support devices or systems<sup>2</sup> with the express written approval of OSRAM OS.

<sup>1</sup> A critical component is a component used in a life-support device or system whose failure can reasonably be expected to cause the failure of that life-support device or system, or to affect its safety or effectiveness of that device or system.

<sup>2</sup> Life support devices or systems are intended (a) to be implanted in the human body, or (b) to support and/or maintain and sustain human life. If they fail, it is reasonable to assume that the health of the user may be endangered.

EU RoHS and China RoHS compliant product



此产品符合欧盟 RoHS 指令的要求；

按照中国的相关法规和标准，不含有毒有害物质或元素。